

## LM62

# 2.7V, 15.6 mV/°C SOT-23 Temperature Sensor

### General Description

The LM62 is a precision integrated-circuit temperature sensor that can sense a 0°C to +90°C temperature range while operating from a single +3.0V supply. The LM62's output voltage is linearly proportional to Celsius (Centigrade) temperature (+15.6 mV/°C) and has a DC offset of +480 mV. The offset allows reading temperatures down to 0°C without the need for a negative supply. The nominal output voltage of the LM62 ranges from +480 mV to +1884 mV for a 0°C to +90°C temperature range. The LM62 is calibrated to provide accuracies of ±2.0°C at room temperature and +2.5°C/−2.0°C over the full 0°C to +90°C temperature range.

The LM62's linear output, +480 mV offset, and factory calibration simplify external circuitry required in a single supply environment where reading temperatures down to 0°C is required. Because the LM62's quiescent current is less than 130 µA, self-heating is limited to a very low 0.2°C in still air. Shutdown capability for the LM62 is intrinsic because its inherent low power consumption allows it to be powered directly from the output of many logic gates.

### Features

- Calibrated linear scale factor of +15.6 mV/°C
- Rated for full 0°C to +90°C range with 3.0V supply
- Suitable for remote applications

### Applications

- Cellular Phones
- Computers
- Power Supply Modules
- Battery Management
- FAX Machines
- Printers
- HVAC
- Disk Drives
- Appliances

### Key Specifications

■ Accuracy at 25°C	±2.0 or ±3.0°C (max)
■ Temperature Slope	+15.6 mV/°C
■ Power Supply Voltage Range	+2.7V to +10V
■ Current Drain @ 25°C	130 µA (max)
■ Nonlinearity	±0.8°C (max)
■ Output Impedance	4.7 kΩ (max)

### Connection Diagram

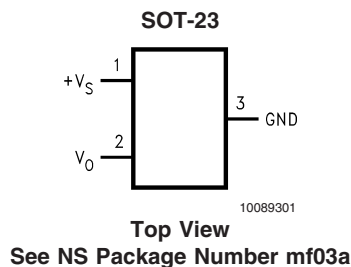

### Typical Application

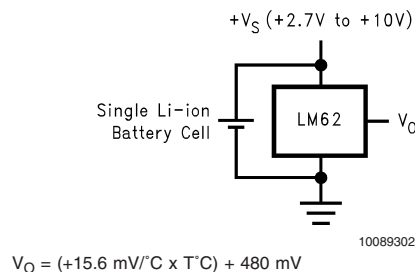

### Ordering Information

Order Number	Device Top Mark	Supplied As
LM62BIM3	T7B	1000 Units, Tape and Reel
LM62BIM3X	T7B	3000 Units, Tape and Reel
LM62CIM3	T7C	1000 Units, Tape and Reel
LM62CIM3X	T7C	3000 Units, Tape and Reel

Temperature (T)	Typical $V_O$
+90°C	+1884 mV
+70°C	+1572 mV
+25°C	870 mV
0°C	+480 mV

**FIGURE 1. Full-Range Centigrade Temperature Sensor (0°C to +90°C) Stabilizing a Crystal Oscillator**

**Absolute Maximum Ratings** (Note 1)

Supply Voltage	+12V to –0.2V
Output Voltage	(+V <sub>S</sub> + 0.6V) to –0.6V
Output Current	10 mA
Input Current at any pin (Note 2)	5 mA
Storage Temperature	–65°C to +150°C
Junction Temperature, max (T <sub>JMAX</sub> )	+125°C
ESD Susceptibility (Note 3) :	
Human Body Model	2500V

Machine Model

250V

**Operating Ratings**(Note 1)

Specified Temperature Range:	<b>T<sub>MIN</sub> ≤ T<sub>A</sub> ≤ T<sub>MAX</sub></b>
LM62B, LM62C	0°C ≤ T <sub>A</sub> ≤ +90°C
Supply Voltage Range (+V <sub>S</sub> )	+2.7V to +10V
Thermal Resistance, θ <sub>JA</sub> (Note 5)	450°C/W

Soldering process must comply with National Semiconductor's Reflow Temperature Profile specifications. Refer to [www.national.com/packaging](http://www.national.com/packaging). (Note 4)

**Electrical Characteristics**

Unless otherwise noted, these specifications apply for +V<sub>S</sub> = +3.0 V<sub>DC</sub>. **Boldface limits apply for T<sub>A</sub> = T<sub>J</sub> = T<sub>MIN</sub> to T<sub>MAX</sub>** ; all other limits T<sub>A</sub> = T<sub>J</sub> = 25°C.

Parameter	Conditions	Typical (Note 6)	LM62B	LM62C	Units (Limit)
			Limits (Note 7)	Limits (Note 7)	
Accuracy (Note 8)			±2.0	±3.0	°C (max)
			<b>+2.5/–2.0</b>	<b>+4.0/–3.0</b>	°C (max)
Output Voltage at 0°C		+480			mV
Nonlinearity (Note 9)			<b>±0.8</b>	<b>±1.0</b>	°C (max)
Sensor Gain (Average Slope)		+16	<b>+16.1</b>	<b>+16.3</b>	mV/°C (max)
			<b>+15.1</b>	<b>+14.9</b>	mV/°C (min)
Output Impedance	+3.0V ≤ +V <sub>S</sub> ≤ +10V		<b>4.7</b>	<b>4.7</b>	kΩ (max)
	0°C ≤ T <sub>A</sub> ≤ +75°C, +V <sub>S</sub> = +2.7V		<b>4.4</b>	<b>4.4</b>	kΩ (max)
Line Regulation (Note 10)	+3.0V ≤ +V <sub>S</sub> ≤ +10V		<b>±1.13</b>	<b>±1.13</b>	mV/V (max)
	+2.7V ≤ +V <sub>S</sub> ≤ +3.3V, 0°C ≤ T <sub>A</sub> ≤ +75°C		<b>±9.7</b>	<b>±9.7</b>	mV (max)
Quiescent Current	+2.7V ≤ +V <sub>S</sub> ≤ +10V	82	130	130	μA (max)
			<b>165</b>	<b>165</b>	μA (max)
Change of Quiescent Current	+2.7V ≤ +V <sub>S</sub> ≤ +10V	±5			μA
Temperature Coefficient of Quiescent Current		0.2			μA/°C
Long Term Stability (Note 11)	T <sub>J</sub> =T <sub>MAX</sub> =+100°C, for 1000 hours	±0.2			°C

**Note 1:** Absolute Maximum Ratings indicate limits beyond which damage to the device may occur. Operating Ratings indicate conditions for which the device is functional, but do not guarantee specific performance limits. For guaranteed specifications and test conditions, see the Electrical Characteristics. The guaranteed specifications apply only for the test conditions listed. Some performance characteristics may degrade when the device is not operated under the listed test conditions.

**Note 2:** When the input voltage (V<sub>I</sub>) at any pin exceeds power supplies (V<sub>I</sub> < GND or V<sub>I</sub> > +V<sub>S</sub>), the current at that pin should be limited to 5 mA.

**Note 3:** The human body model is a 100 pF capacitor discharged through a 1.5 kΩ resistor into each pin. The machine model is a 200 pF capacitor discharged directly into each pin.

**Note 4:** Reflow temperature profiles are different for lead-free and non-lead-free packages.

**Note 5:** The junction to ambient thermal resistance (θ<sub>JA</sub>) is specified without a heat sink in still air.

**Note 6:** Typicals are at T<sub>J</sub> = T<sub>A</sub> = 25°C and represent most likely parametric norm.

**Note 7:** Limits are guaranteed to National's AOQL (Average Outgoing Quality Level).

**Note 8:** Accuracy is defined as the error between the output voltage and +15.6 mV/°C times the device's case temperature plus 480 mV, at specified conditions of voltage, current, and temperature (expressed in °C).

**Note 9:** Nonlinearity is defined as the deviation of the output-voltage-versus-temperature curve from the best-fit straight line, over the device's rated temperature range.

**Note 10:** Regulation is measured at constant junction temperature, using pulse testing with a low duty cycle. Changes in output due to heating effects can be computed by multiplying the internal dissipation by the thermal resistance.

**Note 11:** For best long-term stability, any precision circuit will give best results if the unit is aged at a warm temperature, and/or temperature cycled for at least 46 hours before long-term life test begins. This is especially true when a small (Surface-Mount) part is wave-soldered; allow time for stress relaxation to occur. The majority of the drift will occur in the first 1000 hours at elevated temperatures. The drift after 1000 hours will not continue at the first 1000 hour rate.

# Typical Performance Characteristics

To generate these curves the LM62 was mounted to a printed circuit board as shown in *Figure 2*.

To generate these curves the LM62 was mounted to a printed circuit board as shown in *Figure 2*.

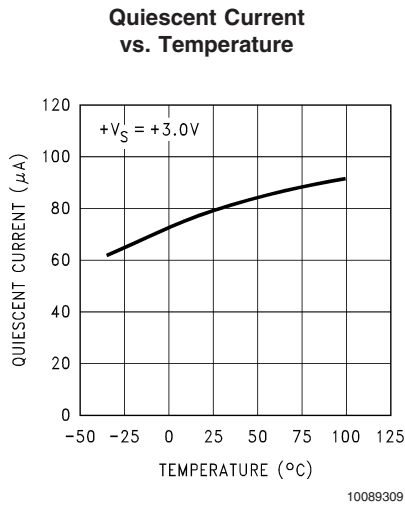
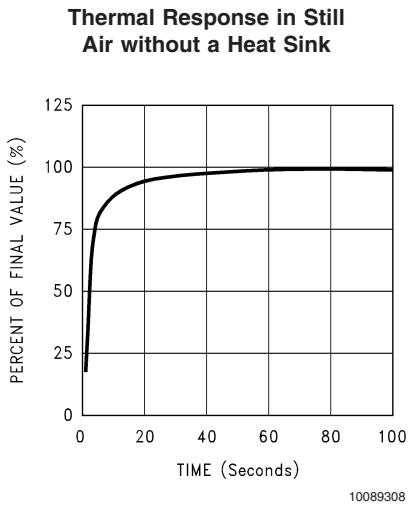
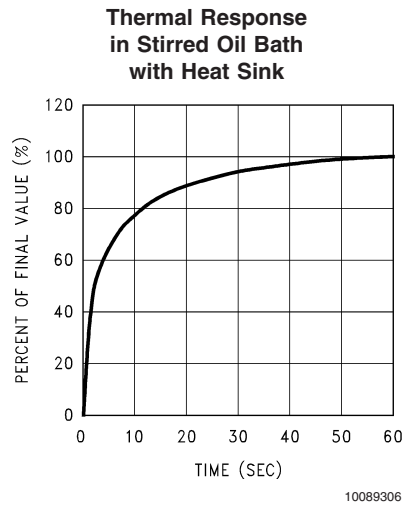
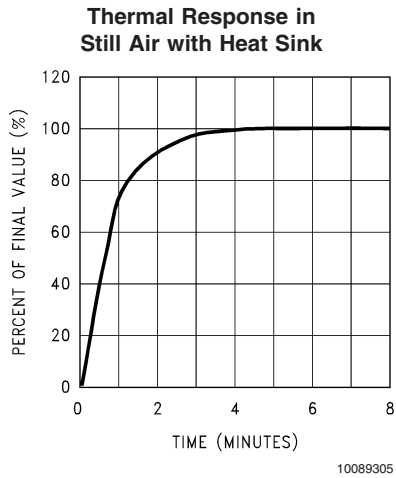
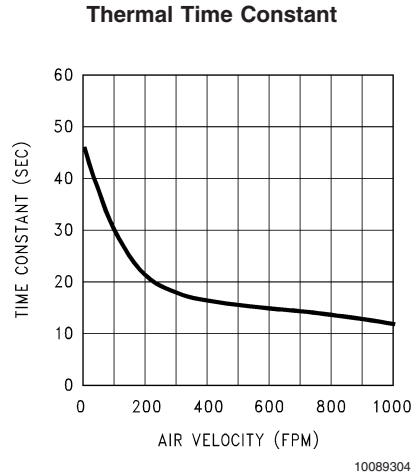
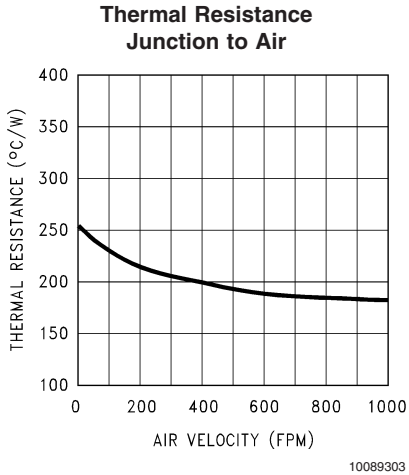

**Typical Performance Characteristics** To generate these curves the LM62 was mounted to a printed circuit board as shown in Figure 2. (Continued)

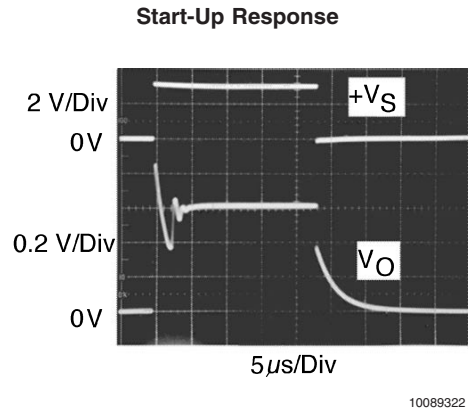
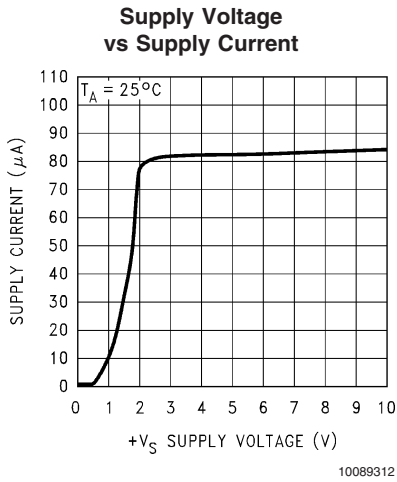
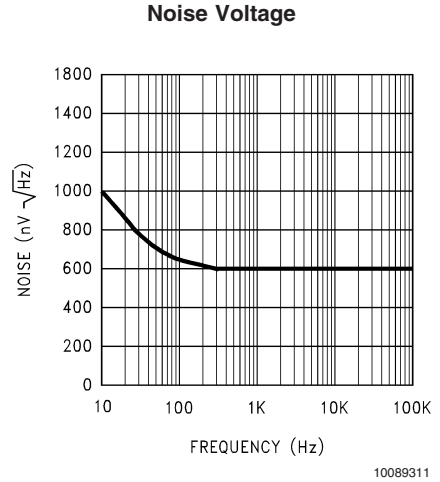
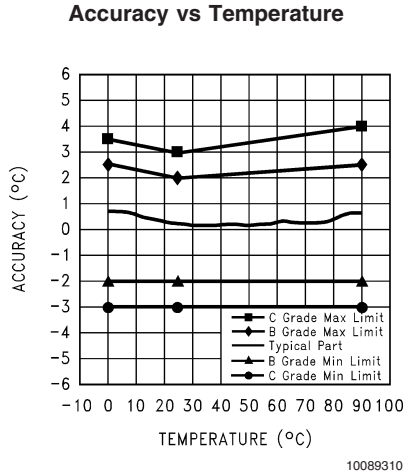

**Circuit Board**

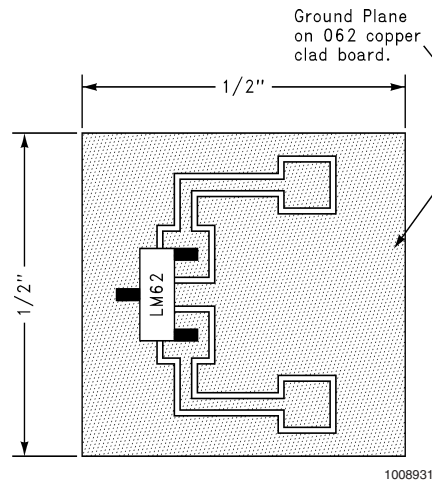

**Printed Circuit Board Used for Heat Sink to Generate All Curves. 1/2" Square Printed Circuit Board with 2 oz. Copper Foil or Similar.**

**FIGURE 2.**

## 1.0 Mounting

The LM62 can be applied easily in the same way as other integrated-circuit temperature sensors. It can be glued or cemented to a surface. The temperature that the LM62 is sensing will be within about  $+0.2^{\circ}\text{C}$  of the surface temperature that LM62's leads are attached to.

This presumes that the ambient air temperature is almost the same as the surface temperature; if the air temperature were much higher or lower than the surface temperature, the actual temperature measured would be at an intermediate temperature between the surface temperature and the air temperature.

To ensure good thermal conductivity the backside of the LM62 die is directly attached to the GND pin. The lands and traces to the LM62 will, of course, be part of the printed circuit board, which is the object whose temperature is being measured. These printed circuit board lands and traces will not cause the LM62's temperature to deviate from the desired temperature.

Alternatively, the LM62 can be mounted inside a sealed-end metal tube, and can then be dipped into a bath or screwed into a threaded hole in a tank. As with any IC, the LM62 and accompanying wiring and circuits must be kept insulated and dry, to avoid leakage and corrosion. This is especially true if the circuit may operate at cold temperatures where condensation can occur. Printed-circuit coatings and varnishes such as Humiseal and epoxy paints or dips are often used to ensure that moisture cannot corrode the LM62 or its connections.

The thermal resistance junction to ambient ( $\theta_{JA}$ ) is the parameter used to calculate the rise of a device junction temperature due to its power dissipation. For the LM62 the equation used to calculate the rise in the die temperature is as follows:

$$T_J = T_A + \theta_{JA} [(+V_S I_Q) + (+V_S - V_O) I_L]$$

where  $I_Q$  is the quiescent current and  $I_L$  is the load current on the output. Since the LM62's junction temperature is the actual temperature being measured care should be taken to minimize the load current that the LM62 is required to drive.

The table shown in *Figure 3* summarizes the rise in die temperature of the LM62 without any loading, and the thermal resistance for different conditions.

	SOT-23 no heat sink (Note 13)		SOT-23 small heat fin (Note 12)	
	$\theta_{JA}$ ( $^{\circ}\text{C}/\text{W}$ )	$T_J - T_A$ ( $^{\circ}\text{C}$ )	$\theta_{JA}$ ( $^{\circ}\text{C}/\text{W}$ )	$T_J - T_A$ ( $^{\circ}\text{C}$ )
Still air	450	0.17	260	0.1
Moving air			180	0.07

**Note 12:** Heat sink used is  $\frac{1}{2}$ " square printed circuit board with 2 oz. foil with part attached as shown in *Figure 2*.

**Note 13:** Part soldered to 30 gauge wire.

**FIGURE 3. Temperature Rise of LM62 Due to Self-Heating and Thermal Resistance ( $\theta_{JA}$ )**

## 2.0 Capacitive Loads

The LM62 handles capacitive loading well. Without any special precautions, the LM62 can drive any capacitive load as shown in *Figure 4*. Over the specified temperature range the LM62 has a maximum output impedance of  $4.7\text{ k}\Omega$ . In an extremely noisy environment it may be necessary to add some filtering to minimize noise pickup. It is recommended that  $0.1\text{ }\mu\text{F}$  be added from  $+V_S$  to GND to bypass the power supply voltage, as shown in *Figure 5*. In a noisy environment it may be necessary to add a capacitor from the output to ground. A  $1\text{ }\mu\text{F}$  output capacitor with the  $4.7\text{ k}\Omega$  maximum output impedance will form a  $34\text{ Hz}$  lowpass filter. Since the thermal time constant of the LM62 is much slower than the  $30\text{ ms}$  time constant formed by the RC, the overall response time of the LM62 will not be significantly affected. For much larger capacitors this additional time lag will increase the overall response time of the LM62.

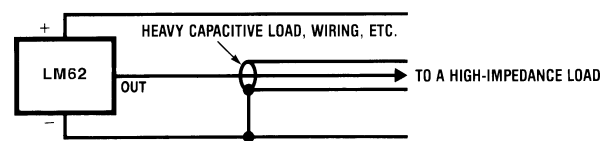

10089315

**FIGURE 4. LM62 No Decoupling Required for Capacitive Load**

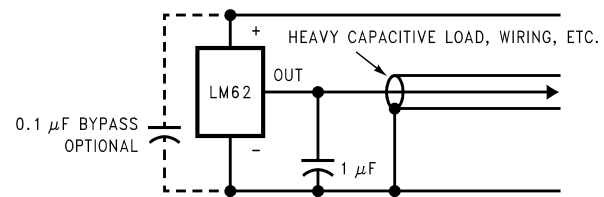

10089316

**FIGURE 5. LM62 with Filter for Noisy Environment**

## 2.0 Capacitive Loads (Continued)

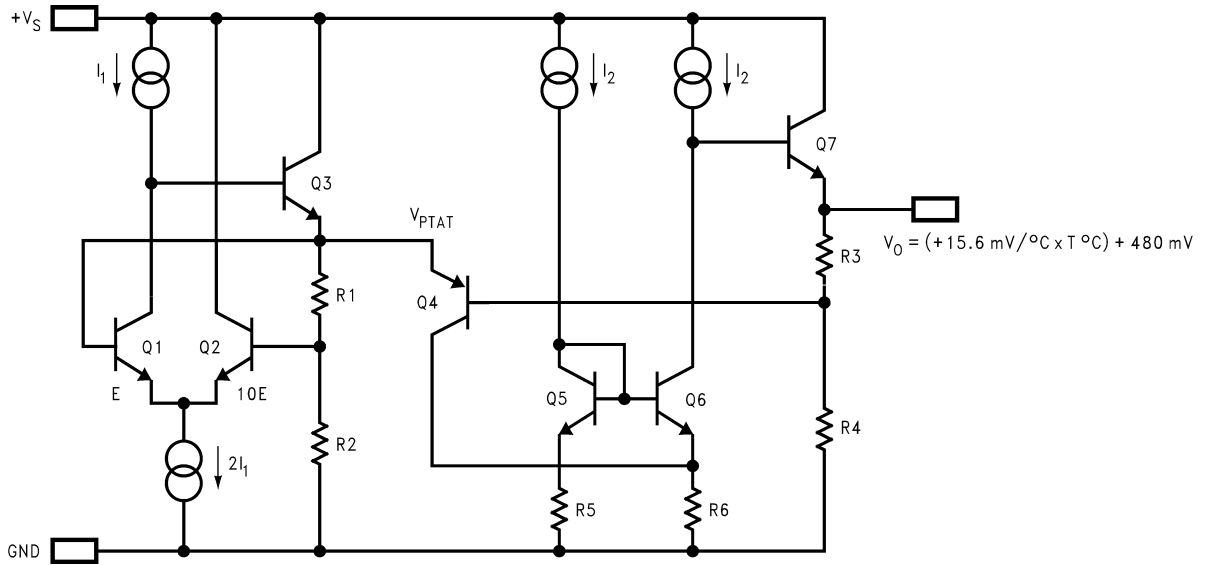

10089317

FIGURE 6. Simplified Schematic

## 3.0 Applications Circuits

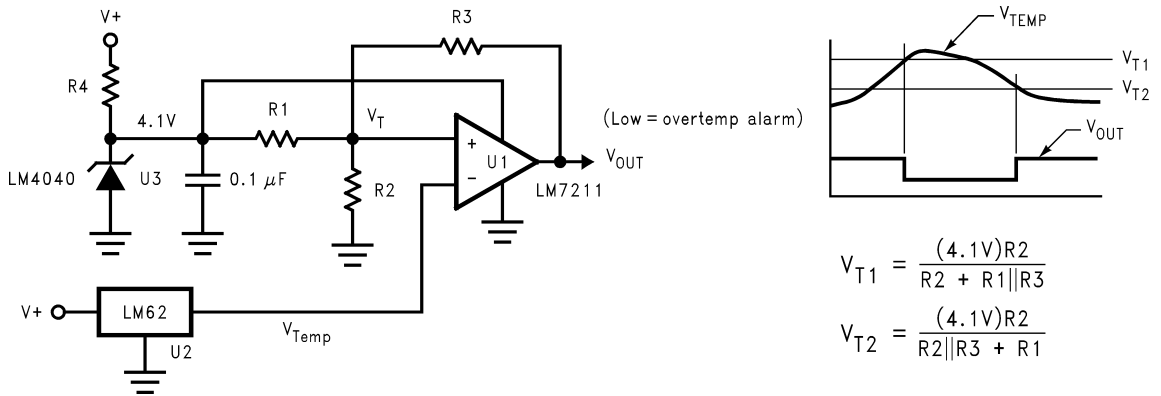

$$V_{T1} = \frac{(4.1V)R2}{R2 + R1 || R3}$$

$$V_{T2} = \frac{(4.1V)R2}{R2 || R3 + R1}$$

10089318

FIGURE 7. Centigrade Thermostat

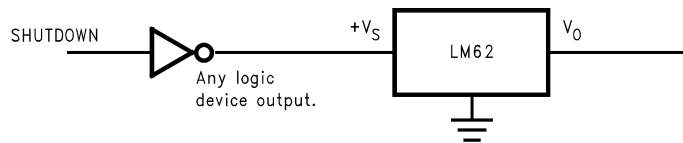

10089319

FIGURE 8. Conserving Power Dissipation with Shutdown

**Physical Dimensions** inches (millimeters) unless otherwise noted

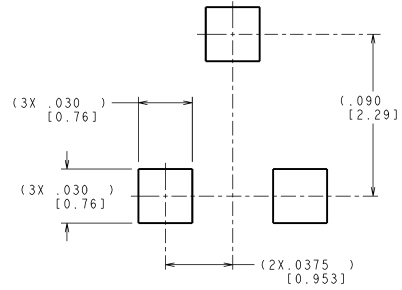
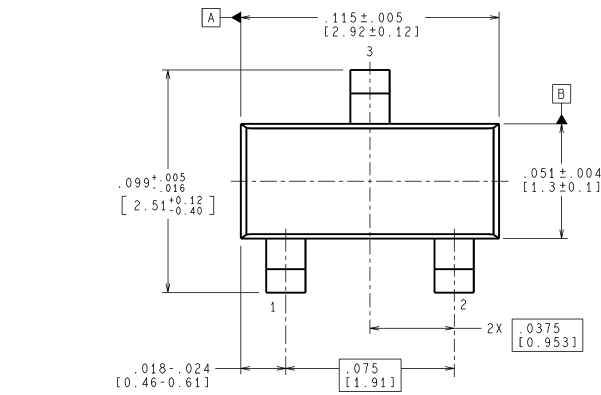

RECOMMENDED LAND PATTERN

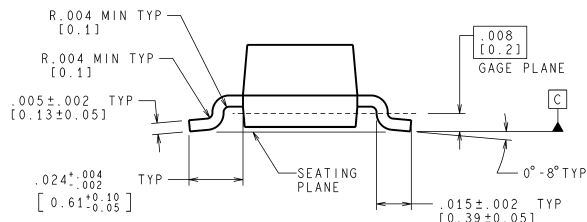
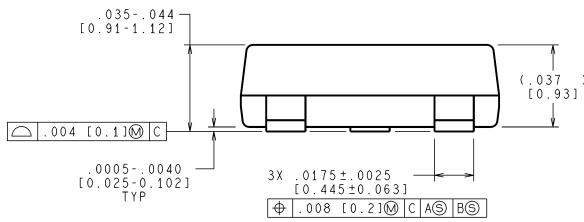

CONTROLLING DIMENSION IS INCH  
VALUES IN [ ] ARE MILLIMETERS

MF03A (Rev B)

**SOT-23 Molded Small Outline Transistor Package (M3)**  
**Order Number LM62BIM3 or LM62CIM3**  
**NS Package Number mf03a**

National does not assume any responsibility for use of any circuitry described, no circuit patent licenses are implied and National reserves the right at any time without notice to change said circuitry and specifications.  
For the most current product information visit us at [www.national.com](http://www.national.com).

**LIFE SUPPORT POLICY**

NATIONAL'S PRODUCTS ARE NOT AUTHORIZED FOR USE AS CRITICAL COMPONENTS IN LIFE SUPPORT DEVICES OR SYSTEMS WITHOUT THE EXPRESS WRITTEN APPROVAL OF THE PRESIDENT AND GENERAL COUNSEL OF NATIONAL SEMICONDUCTOR CORPORATION. As used herein:

1. Life support devices or systems are devices or systems which, (a) are intended for surgical implant into the body, or (b) support or sustain life, and whose failure to perform when properly used in accordance with instructions for use provided in the labeling, can be reasonably expected to result in a significant injury to the user.
2. A critical component is any component of a life support device or system whose failure to perform can be reasonably expected to cause the failure of the life support device or system, or to affect its safety or effectiveness.

**BANNED SUBSTANCE COMPLIANCE**

National Semiconductor manufactures products and uses packing materials that meet the provisions of the Customer Products Stewardship Specification (CSP-9-111C2) and the Banned Substances and Materials of Interest Specification (CSP-9-111S2) and contain no "Banned Substances" as defined in CSP-9-111S2.

Leadfree products are RoHS compliant.



**National Semiconductor**  
**Americas Customer Support Center**  
Email: [new.feedback@nsc.com](mailto:new.feedback@nsc.com)  
Tel: 1-800-272-9959

**National Semiconductor**  
**Europe Customer Support Center**  
Fax: +49 (0) 180-530 85 86  
Email: [europe.support@nsc.com](mailto:europe.support@nsc.com)  
Deutsch Tel: +49 (0) 69 9508 6208  
English Tel: +44 (0) 870 24 0 2171  
Français Tel: +33 (0) 1 41 91 8790

**National Semiconductor**  
**Asia Pacific Customer Support Center**  
Email: [ap.support@nsc.com](mailto:ap.support@nsc.com)

**National Semiconductor**  
**Japan Customer Support Center**  
Fax: 81-3-5639-7507  
Email: [jpn.feedback@nsc.com](mailto:jpn.feedback@nsc.com)  
Tel: 81-3-5639-7560